

RGB LED STRIP



FEATURES:

- Super bright SMD 5050 LEDs
- Painted FPC underlay
- Long lifetime of over 100,000 hrs
- Fast and easy installation with 3M adhesive tape
- No UV emission
- Wide viewing angle
- Low energy consumption
- High flexibility
- Can be cut every 5-10 cm
- Made in the EU

Technical specifications:

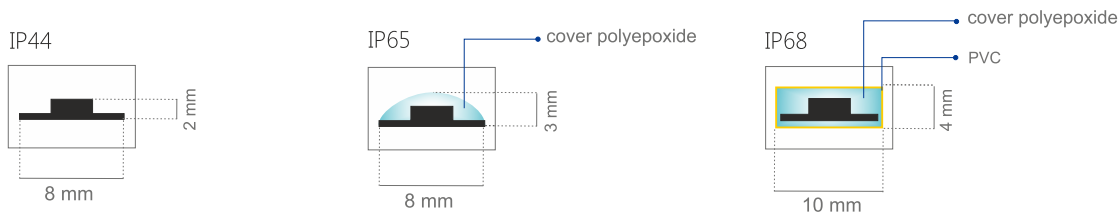

Symbol	Colour	LED Qty. /5m	LED Qty. /1m	IP Rating	Voltage	Cutting Unit	Power
TS5050-150-RGB	RGB	150 pcs	30 pcs	IP44, IP65, IP68	12V DC	3 LED (100 mm)	7,2W/m
TS5050-300-RGB	RGB	300 pcs	60 pcs	IP44, IP65, IP68	12V DC	3 LED (50 mm)	14,4W/m

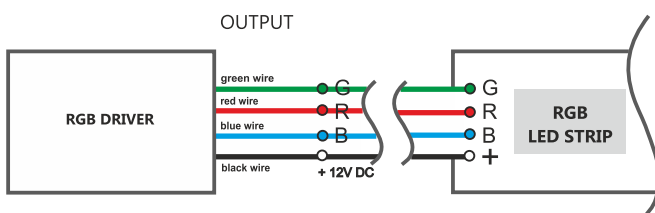

RGB REMOTE CONTROL FOR LED STRIP



Schematics:

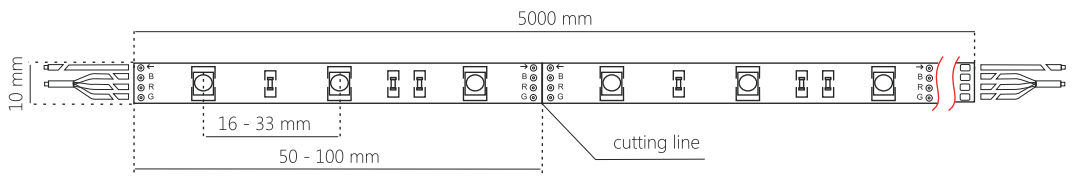

Connection of LED strip to power supply:

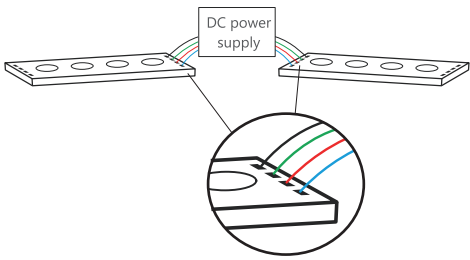

Connecting the LED strip to a number of power supplies:

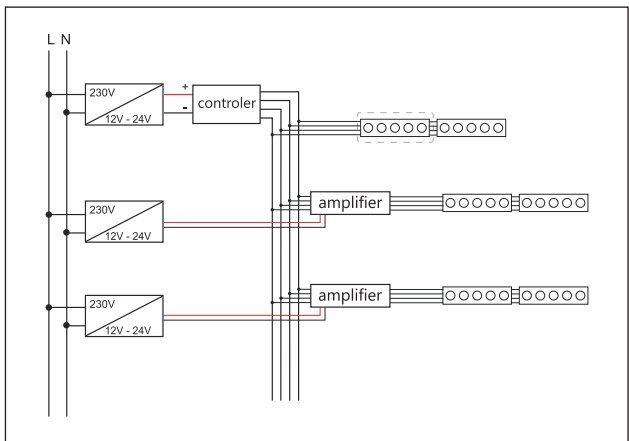

Proposed power supply:

IP20

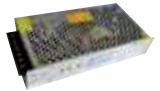

- MEAN WELL [RS-50](#)
- MEAN WELL [RS-75](#)
- MEAN WELL [RS-150](#)

IP67



- MEAN WELL [LPH-18](#)
- MEAN WELL [LPV-35](#)
- MEAN WELL [LPV-60](#)
- MEAN WELL [LPV-100](#)

